

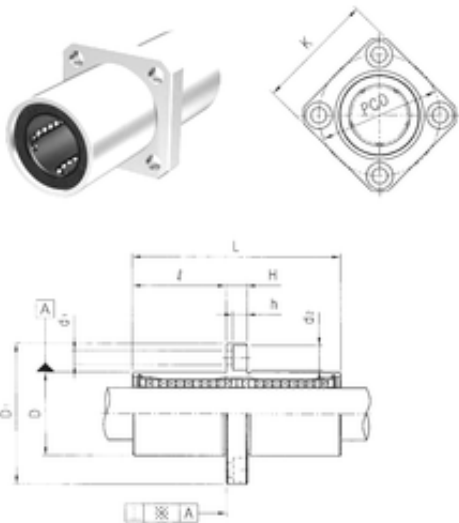

Bearing equipment manufacturing Co., Ltd



LMKM20UU Bearing 2D drawings and 3D CAD models

Samick LMKM20UU linear bearings

Bearing No. LMKM20UU

Bore Diameter	20 mm
Outer Diameter	32 mm
d	20 mm
D	32 mm
d1	5,5 mm
d2	9,5 mm
h	5,4 mm
D1	54 mm
H	8 mm
K	42 mm
L	80 mm
PCD	43 mm
	36 Tolerance h14
Tolerance perpendicularity (C)	20
Weight	0,26 Kg
Basic dynamic load rating (C)	1,4 kN