

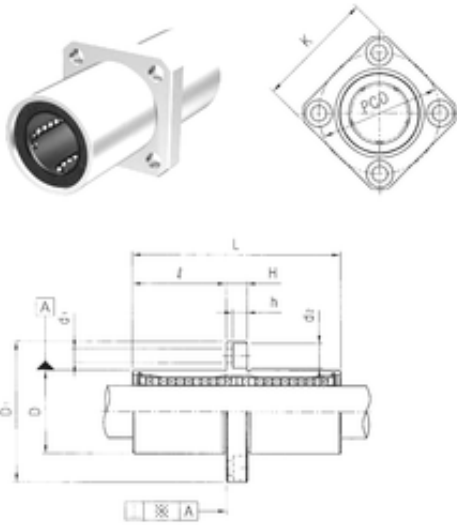

Bearing equipment manufacturing Co., Ltd



LMKM8UU Bearing 2D drawings and 3D CAD models

Samick LMKM8UU linear bearings

Bearing No. LMKM8UU

Bore Diameter	8 mm
Outer Diameter	15 mm
d	8 mm
D	15 mm
d1	3,4 mm
d2	6,5 mm
h	3,3 mm
D1	32 mm
H	5 mm
K	25 mm
L	45 mm
PCD	24 mm
	20 Tolerance h14
Tolerance perpendicularity (C)	15
Weight	0,053 Kg
Basic dynamic load rating (C)	0,43 kN