

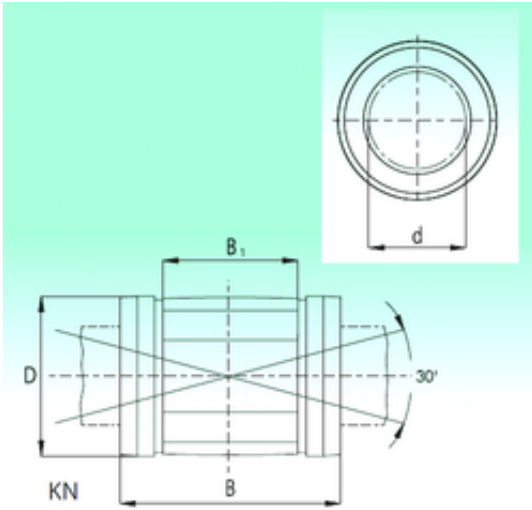

## Bearing equipment manufacturing Co., Ltd



KN2558 Bearing 2D drawings and 3D CAD models

25 mm x 40 mm x 58 mm NBS KN2558 linear bearings

Bearing No. KN2558

Size	25x40x58 mm
Bore Diameter	25 mm
Outer Diameter	40 mm
Width	58 mm
d	25 mm
D	40 mm
B	58 mm
B1	40 mm
Weight	0,122 Kg
Basic dynamic load rating (C)	2,5 kN