

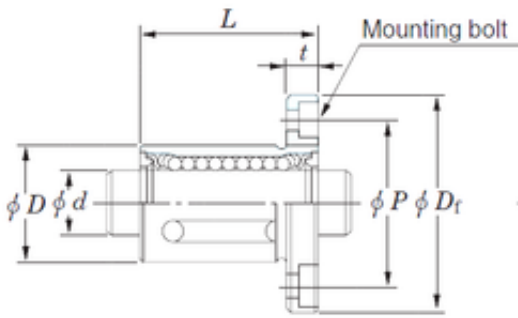

# Bearing equipment manufacturing Co., Ltd



SDMF50 Bearing 2D drawings and 3D CAD models

## KOYO SDMF50 linear bearings

Bearing No. SDMF50

Bore Diameter	50 mm
Outer Diameter	80 mm
Fw	50 mm
D	80 mm
P	98 mm
t	13 mm
D1	116 mm
K	92 mm
L	100 mm
Bolt (G)	M8
Weight	2000 Kg
Basic dynamic load rating (C)	4420 kN