

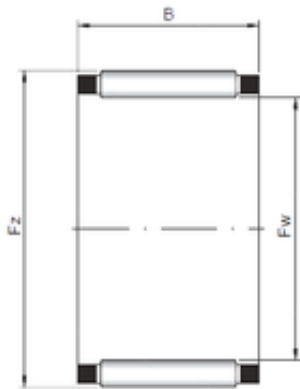

Bearing equipment manufacturing Co., Ltd

ISO K03x06x07 needle roller bearings



Bearing No. K03x06x07

Size	3x6x7 mm
Bore Diameter	3 mm
Outer Diameter	6 mm
Width	7 mm
Fw	3 mm
Ew	6 mm
B	7 mm

K03x06x07 Bearing 2D drawings and 3D CAD models