

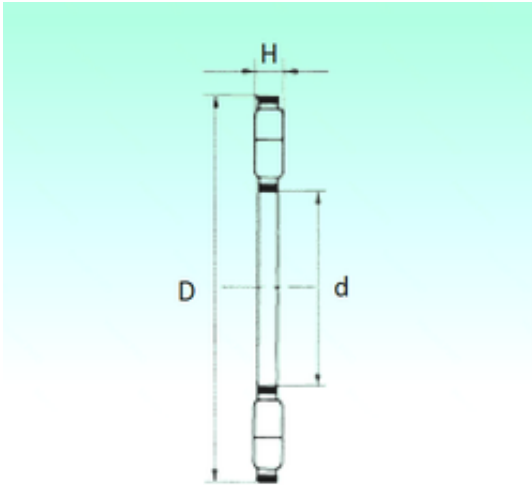

Bearing equipment manufacturing Co., Ltd



NBS K89416-M thrust roller bearings

Bearing No. K89416-M

Bore Diameter	80 mm
Outer Diameter	170 mm
d	80 mm
D	170 mm
Dw	18 mm
Weight	1,41 Kg
Basic dynamic load rating (C)	559,6 kN
Basic static load rating (C0)	1769,5 kN

K89416-M Bearing 2D drawings and 3D CAD models